



New Product
V20100C, VF20100C, VB20100C & VI20100C

Vishay General Semiconductor

Dual High-Voltage Trench MOS Barrier Schottky Rectifier

Ultra Low $V_F = 0.50\text{ V}$ at $I_F = 5\text{ A}$

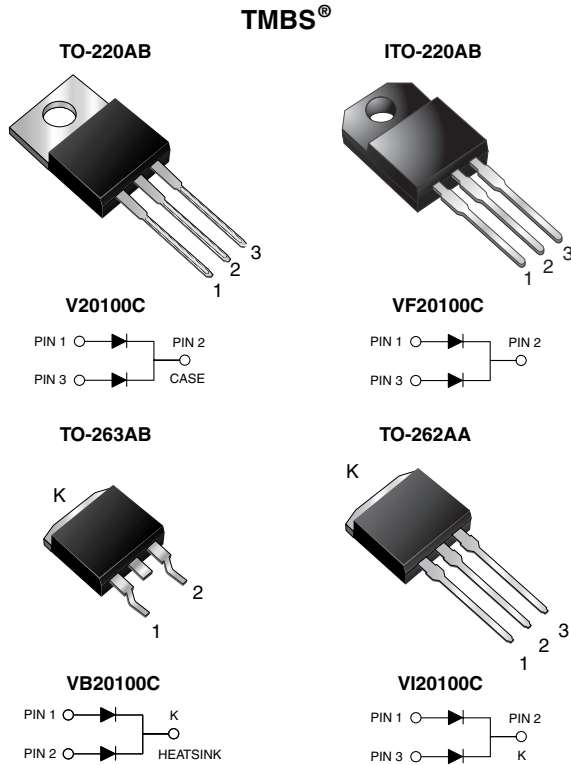

FEATURES

- Trench MOS Schottky technology
- Low forward voltage drop, low power losses
- High efficiency operation
- Meets MSL level 1, per J-STD-020, LF maximum peak of 245 °C (for TO-263AB package)
- Solder dip 260 °C, 40 s (for TO-220AB, ITO-220AB and TO-262AA package)
- Component in accordance to RoHS 2002/95/EC and WEEE 2002/96/EC



RoHS
COMPLIANT

TYPICAL APPLICATIONS

For use in high frequency inverters, switching power supplies, freewheeling diodes, OR-ing diode, dc-to-dc converters and reverse battery protection.

MECHANICAL DATA

Case: TO-220AB, ITO-220AB, TO-263AB and TO-262AA

Epoxy meets UL 94V-0 flammability rating

Terminals: Matte tin plated leads, solderable per J-STD-002 and JESD22-B102

E3 suffix for consumer grade, meets JESD 201 class 1A whisker test

Polarity: As marked

Mounting Torque: 10 in-lbs maximum

PRIMARY CHARACTERISTICS

$I_{F(AV)}$	2 x 10 A
V_{RRM}	100 V
I_{FSM}	150 A
V_F at $I_F = 10\text{ A}$	0.58 V
T_J max.	150 °C

MAXIMUM RATINGS ($T_A = 25\text{ °C}$ unless otherwise noted)

PARAMETER	SYMBOL	V20100C	VF20100C	VB20100C	VI20100C	UNIT
Maximum repetitive peak reverse voltage	V_{RRM}	100				V
Maximum average forward rectified current (Fig. 1) per device per diode	$I_{F(AV)}$	20 10				A
Peak forward surge current 8.3 ms single half sine-wave superimposed on rated load per diode per diode	I_{FSM}	150				A
Isolation voltage (ITO-220AB only) from terminal to heatsink $t = 1\text{ min}$	V_{AC}	1500				V
Operating junction and storage temperature range	T_J, T_{STG}	- 40 to + 150				°C

ELECTRICAL CHARACTERISTICS ($T_A = 25\text{ }^\circ\text{C}$ unless otherwise noted)						
PARAMETER	TEST CONDITIONS		SYMBOL	TYP.	MAX.	UNIT
Breakdown voltage per diode	$I_R = 10\text{ mA}$	$T_A = 25\text{ }^\circ\text{C}$	V_{BR}	105 (minimum)	-	V
Instantaneous forward voltage per diode ⁽¹⁾	$I_F = 5\text{ A}$	$T_A = 25\text{ }^\circ\text{C}$	V_F	0.55	-	V
	$I_F = 10\text{ A}$	$T_A = 25\text{ }^\circ\text{C}$		0.65	0.79	
Reverse current per diode ⁽²⁾	$V_R = 70\text{ V}$	$T_A = 25\text{ }^\circ\text{C}$	I_R	17	-	μA
	$V_R = 100\text{ V}$	$T_A = 125\text{ }^\circ\text{C}$		5.3	-	mA
	$V_R = 70\text{ V}$	$T_A = 25\text{ }^\circ\text{C}$	I_R	-	800	μA
	$V_R = 100\text{ V}$	$T_A = 125\text{ }^\circ\text{C}$		12	25	mA

Notes:

(1) Pulse test: 300 μs pulse width, 1 % duty cycle

(2) Pulse test: Pulse width $\leq 40\text{ ms}$

THERMAL CHARACTERISTICS ($T_A = 25\text{ }^\circ\text{C}$ unless otherwise noted)						
PARAMETER	SYMBOL	V20100C	VF20100C	VB20100C	VI20100C	UNIT
Typical thermal resistance per diode	$R_{\theta JC}$	2.8	5.5	2.8	2.8	$^\circ\text{C/W}$

ORDERING INFORMATION (Example)						
PACKAGE	PREFERRED P/N	UNIT WEIGHT (g)	PACKAGE CODE	BASE QUANTITY	DELIVERY MODE	
TO-220AB	V20100C-E3/4W	1.881	4W	50/tube	Tube	
ITO-220AB	VF20100C-E3/4W	1.75	4W	50/tube	Tube	
TO-263AB	VB20100C-E3/4W	1.39	4W	50/tube	Tube	
TO-263AB	VB20100C-E3/8W	1.39	8W	800/reel	Tape and reel	
TO-262AA	VI20100C-E3/4W	1.452	4W	50/tube	Tube	

RATINGS AND CHARACTERISTICS CURVES

($T_A = 25\text{ }^\circ\text{C}$ unless otherwise noted)

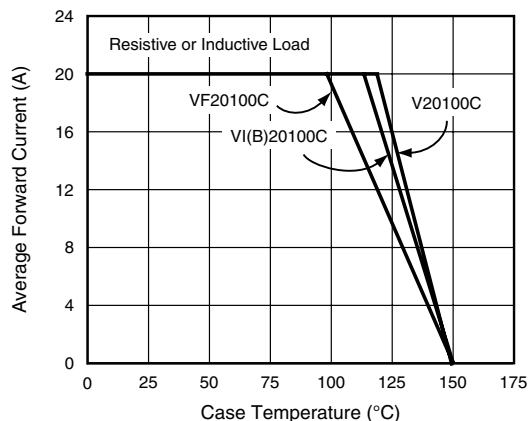

Figure 1. Maximum Forward Current Derating Curve

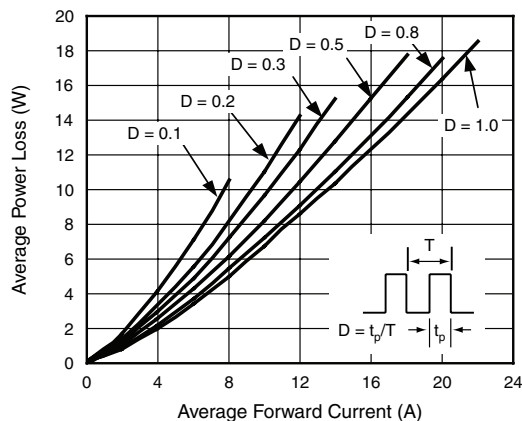

Figure 2. Forward Power Loss Characteristics Per Diode

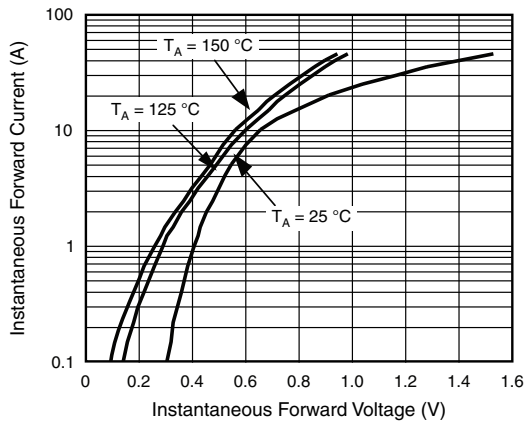

Figure 3. Typical Instantaneous Forward Characteristics Per Diode

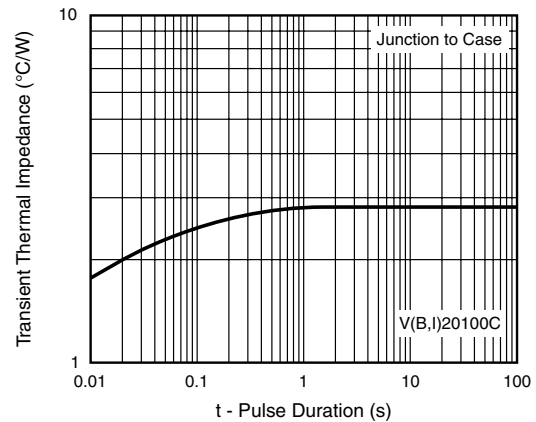

Figure 6. Typical Transient Thermal Impedance Per Diode

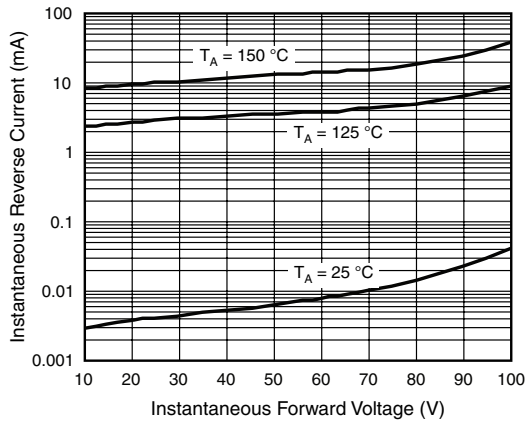

Figure 4. Typical Reverse Characteristics Per Diode

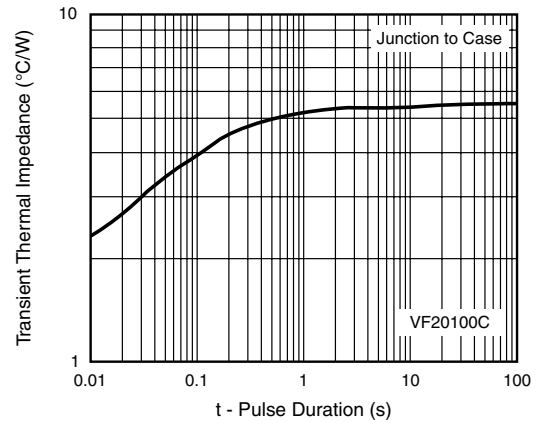

Figure 7. Typical Transient Thermal Impedance Per Diode

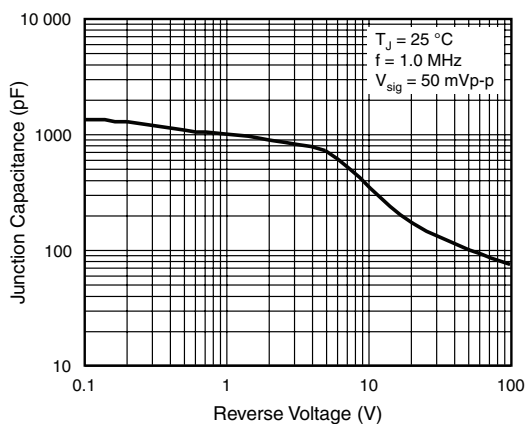
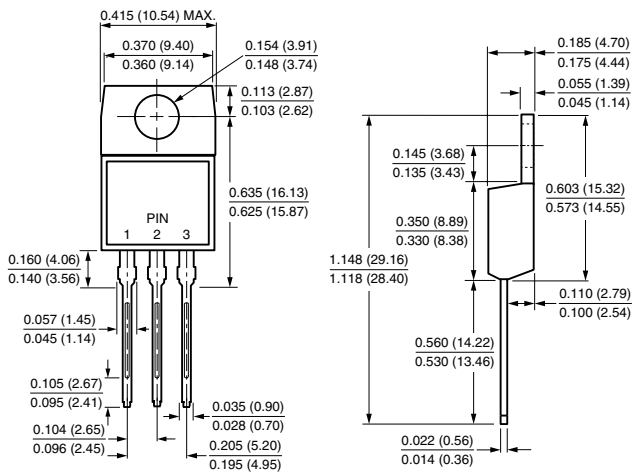

Figure 5. Typical Junction Capacitance Per Diode

PACKAGE OUTLINE DIMENSIONS in inches (millimeters)

TO-220AB



ITO-220AB

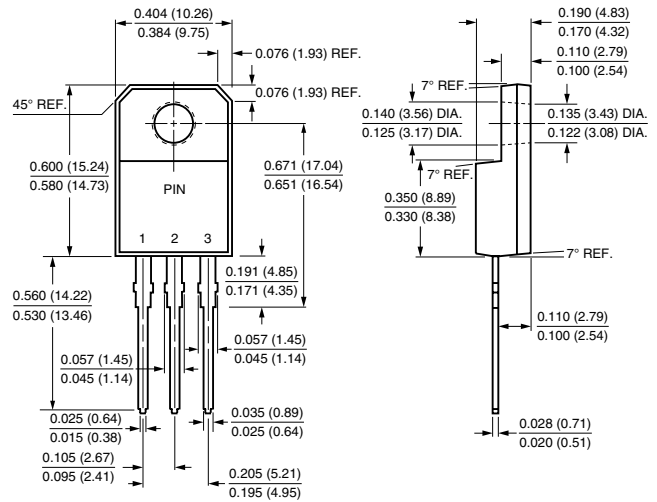

TO-262AA

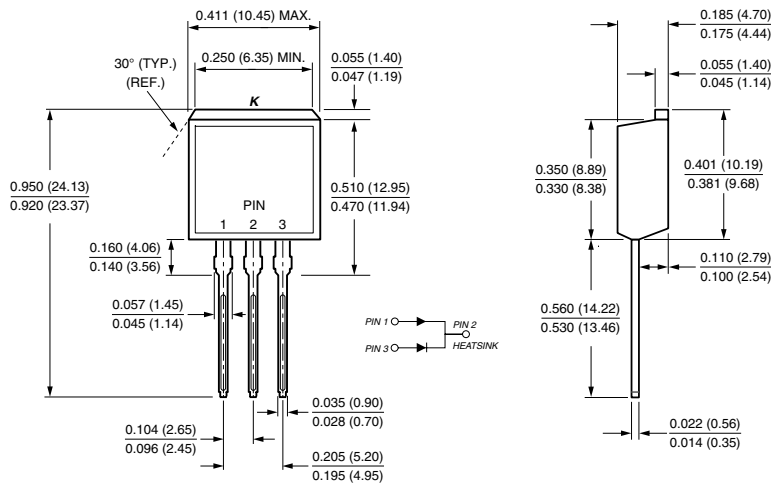

TO-263AB

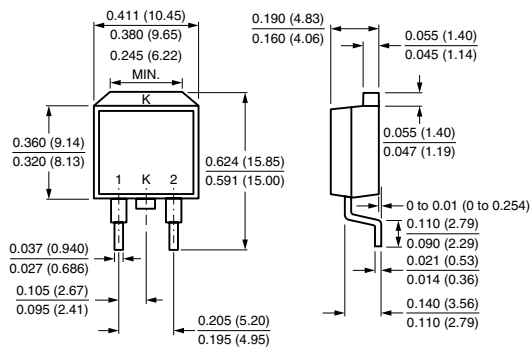

Mounting Pad Layout

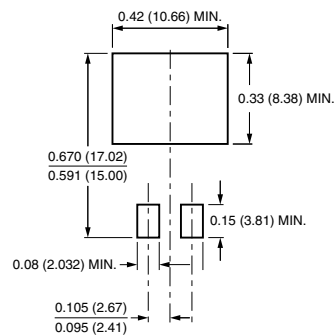



Disclaimer

All product specifications and data are subject to change without notice.

Vishay Intertechnology, Inc., its affiliates, agents, and employees, and all persons acting on its or their behalf (collectively, "Vishay"), disclaim any and all liability for any errors, inaccuracies or incompleteness contained herein or in any other disclosure relating to any product.

Vishay disclaims any and all liability arising out of the use or application of any product described herein or of any information provided herein to the maximum extent permitted by law. The product specifications do not expand or otherwise modify Vishay's terms and conditions of purchase, including but not limited to the warranty expressed therein, which apply to these products.

No license, express or implied, by estoppel or otherwise, to any intellectual property rights is granted by this document or by any conduct of Vishay.

The products shown herein are not designed for use in medical, life-saving, or life-sustaining applications unless otherwise expressly indicated. Customers using or selling Vishay products not expressly indicated for use in such applications do so entirely at their own risk and agree to fully indemnify Vishay for any damages arising or resulting from such use or sale. Please contact authorized Vishay personnel to obtain written terms and conditions regarding products designed for such applications.

Product names and markings noted herein may be trademarks of their respective owners.