

Part Number: DC-7G3HWA

Green
Bright Red

Features

- SUITABLE FOR LEVEL INDICATORS.
- LOW CURRENT OPERATION.
- EXCELLENT ON/OFF CONTRAST.
- WIDE VIEWING ANGLE.
- END STACKABLE.
- MECHANICALLY RUGGED.
- BI-COLOR VERSION AVAILABLE.
- STANDARD : GRAY FACE, WHITE SEGMENT.
- RoHS COMPLIANT.

Description

The Green source color devices are made with Gallium Phosphide Green Light Emitting Diode.

The Bright Red source color devices are made with Gallium Phosphide Red Light Emitting Diode.

Package Dimensions & Internal Circuit Diagram

BAR A~G : GREEN(G)
BAR H~J : RED(H)

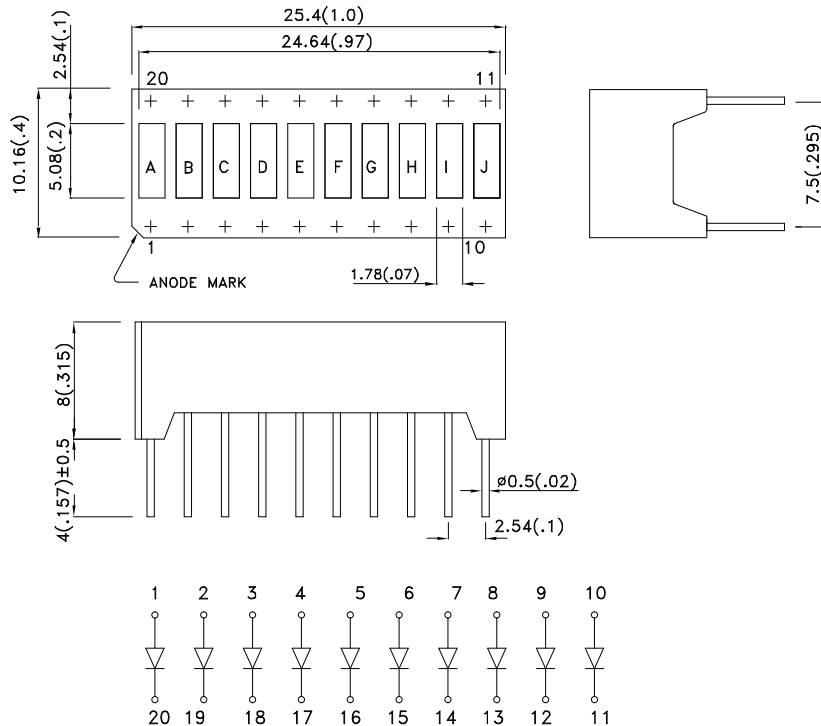

Notes:

1. All dimensions are in millimeters (inches), Tolerance is $\pm 0.25(0.01)$ unless otherwise noted.
2. Specifications are subject to change without notice.



Selection Guide

Part No.	Dice	Lens Type	Iv (ucd) [1] @ 10mA		Description
			Min.	Typ.	
DC-7G3HWA	Green (GaP)	WHITE DIFFUSED	3000	16000	10 Segments Bargraph-Display 7xGreen 3xBright Red
	Bright Red (GaP)		800	4000	

Note:

1. Luminous intensity/ luminous Flux: +/-15%.

Electrical / Optical Characteristics at TA=25°C

Symbol	Parameter	Device	Typ.	Max.	Units	Test Conditions
λ_{peak}	Peak Wavelength	Green Bright Red	565 700		nm	I _F =20mA
λ_D [1]	Dominant Wavelength	Green Bright Red	568 660		nm	I _F =20mA
$\Delta\lambda_{1/2}$	Spectral Line Half-width	Green Bright Red	30 45		nm	I _F =20mA
C	Capacitance	Green Bright Red	15 40		pF	V _F =0V;f=1MHz
V _F [2]	Forward Voltage	Green Bright Red	2.2 2.25	2.5 2.5	V	I _F =20mA
I _R	Reverse Current	Green Bright Red		10	uA	V _R =5V

Notes:

1. Wavelength: +/-1nm.
2. Forward Voltage: +/-0.1V.

Absolute Maximum Ratings at TA=25°C

Parameter	Green	Bright Red	Units
Power dissipation	62.5	62.5	mW
DC Forward Current	25	25	mA
Peak Forward Current [1]	140	130	mA
Reverse Voltage	5		V
Operating/Storage Temperature	-40°C To +85°C		
Lead Solder Temperature [2]	260°C For 3-5 Seconds		

Notes:

1. 1/10 Duty Cycle, 0.1ms Pulse Width.
2. 2mm below package base.

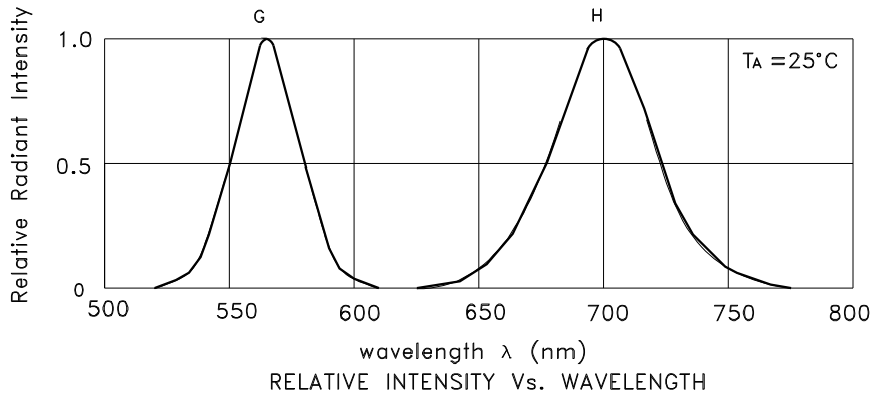

DC-7G3HWA Green

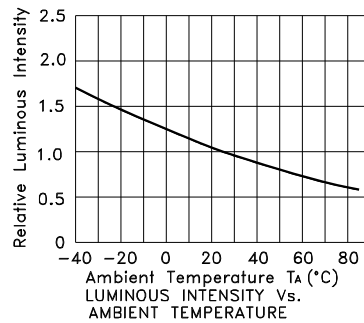
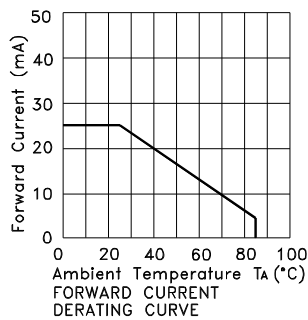
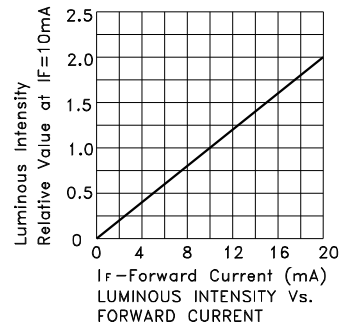
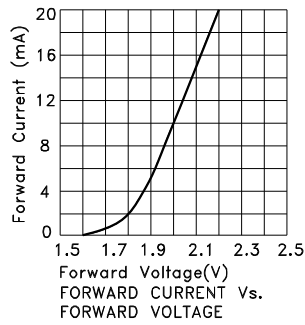

Kingbright

Bright Red

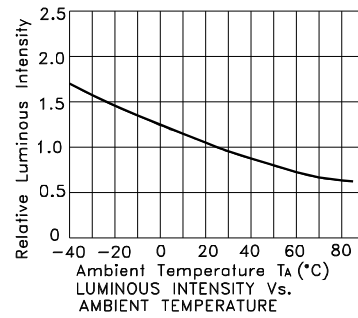
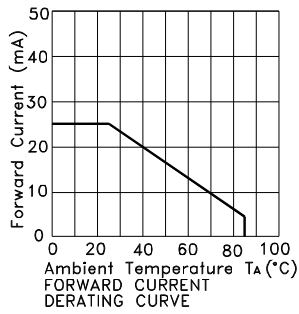
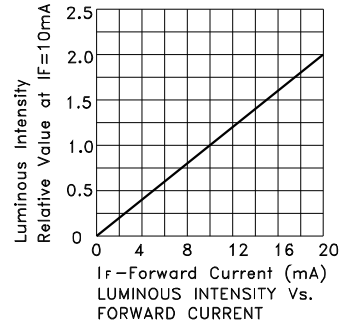
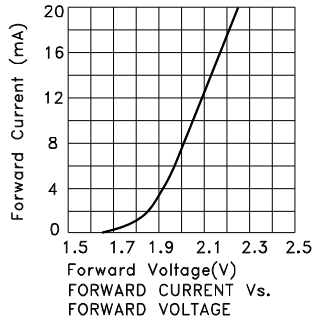

PACKING & LABEL SPECIFICATIONS

DC-7G3HWA

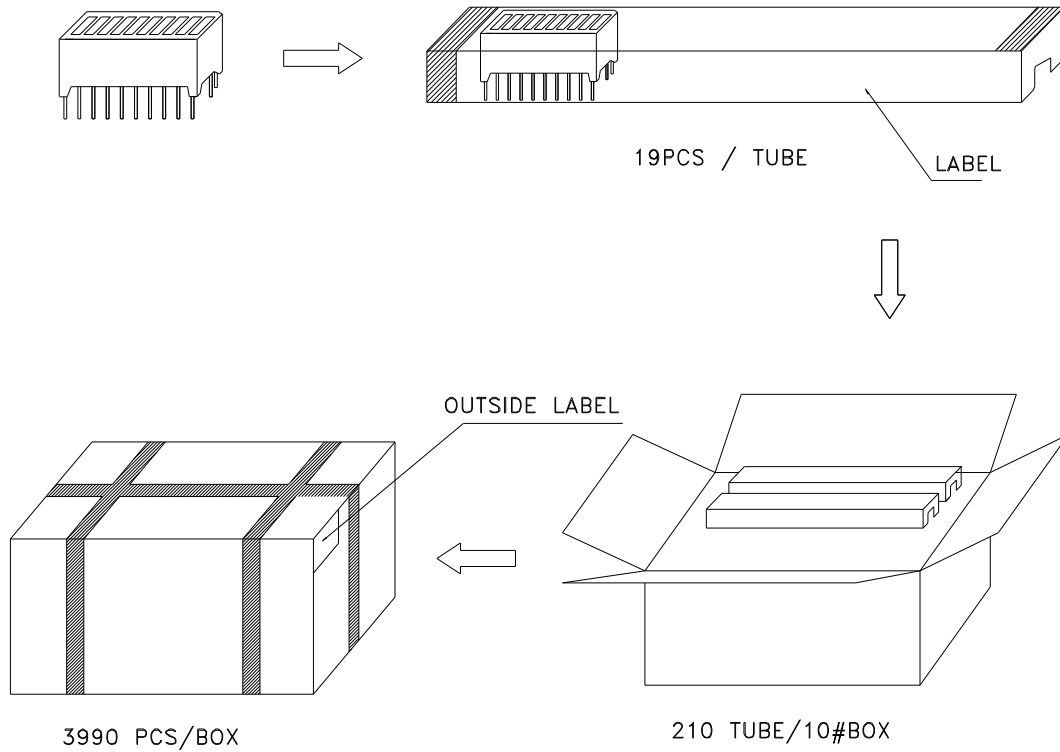

Inside LABEL Paste On The IC-tube

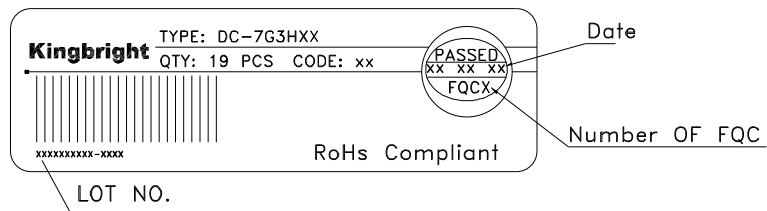

Outside LABEL Paste On The Box

